

Article number: 2310431153S

Description: E+G Levelling elements
LX.30-SW17-SST-M6X34-S

Measures

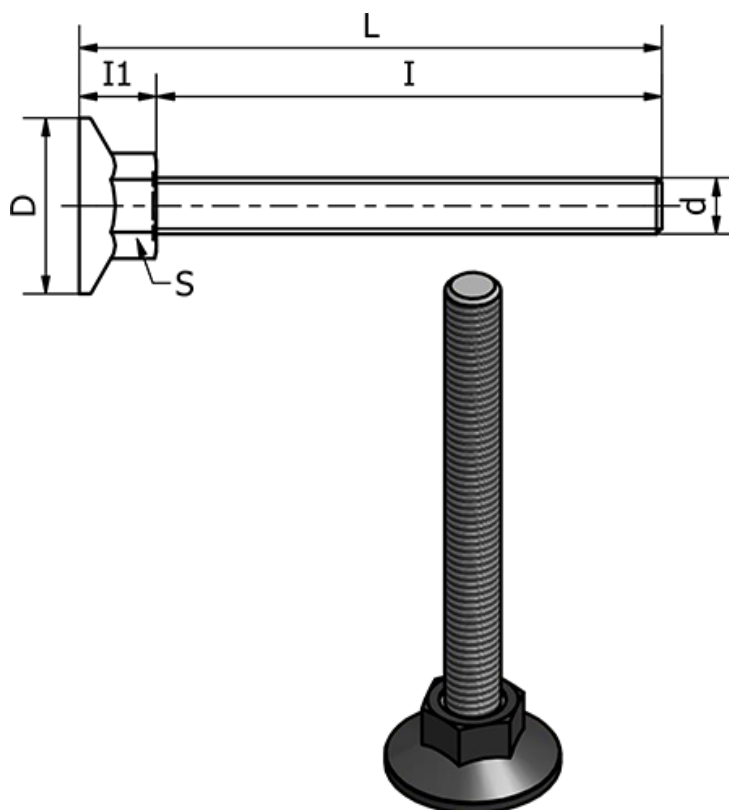

d = M6

D = 30

I = 34

I1 = 12

L = 46

S = 17

Static load in (N) = 1500

Type = AISI 304 Rustfast

Weight (g) = -